



Scan here for access to solution website page for other documents

Stravimech Bearing-S1 Datasheet



Stravimech Bearing-S1 is a spring mount featuring a single metal spring isolator. It can be paired with mounting plates - either bottom only or both top and bottom - and a levelling system. This design provides effective noise and vibration isolation for mechanical equipment and enables secure mechanical anchoring. It is especially suitable for low-speed machinery and is available in various load capacities to support both lightweight and heavy equipment.

FEATURES

- Designed to support all types of machinery operating at low frequencies (below 1200 rpm), ensuring effective vibration control
- Offered with 12 spring variants to accommodate design loads up to 4330 N (total loads up to 5000 N), suitable for a wide range of machinery
- Springs are colour-coded for quick and accurate identification on-site
- Available in three configurations - without mounting plate, with bottom mounting plate (SP), or with both top and bottom mounting plates (DP) - to suit various installation needs
- Can be equipped with a leveling mechanism for precise height adjustment and alignment
- Metal plates feature an elastomeric layer that improves anti-slip properties and adapts to surface irregularities
- Springs achieve natural frequencies of approximately 3 Hz (S1-1180 - S1-4330 series) to 4 Hz (S1-90 - S1-775 series), ensuring optimal vibration isolation at design loads
- Maximum spring deflection ranges from 25 mm (S1-90 - S1-775 series) to 35 mm (S1-1180 - S1-4330 series) for consistent performance
- Springs are protected with a polyester-based coating, offering excellent resistance to environmental conditions
- Top and bottom cylindrical metal bushings include a visco-elastic putty layer that prevents metal-to-metal contact and promotes sound-stop

DIFFERENT MOUNTING POSSIBILITIES

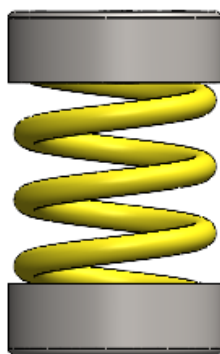

Stravimech Bearing-S1-xx
No mounting plate

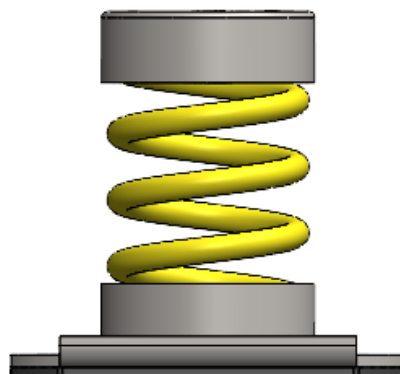

Stravimech Bearing-S1-xx-SP
Bottom mounting plate (SP)

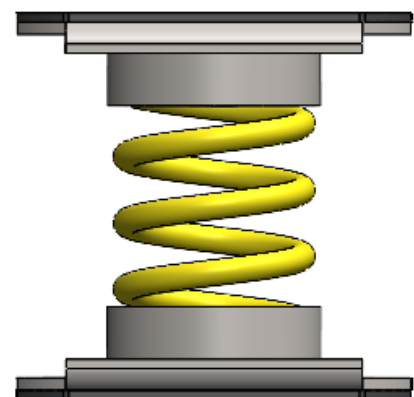

Stravimech Bearing-S1-xx-DP
Bottom and top mounting plate (DP)

Notes:

A Stravimech Bearing-S1 that uses a spring with a design load of 90 N and includes a bottom mounting plate is designated as Stravimech Bearing-S1-90-SP. Similarly, the same bearing with both top and bottom mounting plates is designated as Stravimech Bearing-S1-90-DP. If the bearing is provided without any mounting plates, it is simply referred to as Stravimech Bearing-S1-90.

**No mounting plate**

Model	Reference	Quantity per Box	Weight per Box [kg]	Dimension of Box [mm]
Stravimech Bearing-S1-90	002072	40	6.96	200 x 200 x 230
Stravimech Bearing-S1-155	002075	40	7.52	200 x 200 x 230
Stravimech Bearing-S1-310	002078	40	7.92	200 x 200 x 230
Stravimech Bearing-S1-465	002081	40	9.28	200 x 200 x 230
Stravimech Bearing-S1-620	002084	40	8.72	200 x 200 x 230
Stravimech Bearing-S1-775	002087	40	9.48	200 x 200 x 230
Stravimech Bearing-S1-1180	002090	12	6.45	400 x 200 x 165
Stravimech Bearing-S1-1575	002093	12	6.90	400 x 200 x 165
Stravimech Bearing-S1-1970	002096	12	7.63	400 x 200 x 165
Stravimech Bearing-S1-2755	002099	12	8.05	400 x 200 x 165
Stravimech Bearing-S1-3545	002102	12	8.41	400 x 200 x 165
Stravimech Bearing-S1-4330	002105	12	9.67	400 x 200 x 165

Bottom mounting plate (SP)













Model	Reference	Quantity per Box	Weight per Box [kg]	Dimension of Box [mm]
Stravimech Bearing-S1-90-SP	002073	30	8.82	300 x 250 x 255
Stravimech Bearing-S1-155-SP	002076	30	9.21	300 x 250 x 255
Stravimech Bearing-S1-310-SP	002079	30	9.54	300 x 250 x 255
Stravimech Bearing-S1-465-SP	002082	30	10.56	300 x 250 x 255
Stravimech Bearing-S1-620-SP	002085	30	10.14	300 x 250 x 255
Stravimech Bearing-S1-775-SP	002088	30	10.71	300 x 250 x 255
Stravimech Bearing-S1-1180-SP	002091	12	9.74	300 x 250 x 255
Stravimech Bearing-S1-1575-SP	002094	12	10.16	300 x 250 x 255
Stravimech Bearing-S1-1970-SP	002097	12	10.90	300 x 250 x 255
Stravimech Bearing-S1-2755-SP	002100	12	11.33	300 x 250 x 255
Stravimech Bearing-S1-3545-SP	002103	12	11.69	300 x 250 x 255
Stravimech Bearing-S1-4330-SP	002106	12	12.95	300 x 250 x 255

Bottom and top mounting plate (DP)

Model	Reference	Quantity per Box	Weight per Box [kg]	Dimension of Box [mm]
Stravimech Bearing-S1-90-DP	002074	20	8.18	400 x 200 x 165
Stravimech Bearing-S1-155-DP	002077	20	8.44	400 x 200 x 165
Stravimech Bearing-S1-310-DP	002080	20	8.66	400 x 200 x 165
Stravimech Bearing-S1-465-DP	002083	20	9.34	400 x 200 x 165
Stravimech Bearing-S1-620-DP	002086	20	9.06	400 x 200 x 165
Stravimech Bearing-S1-775-DP	002089	20	9.44	400 x 200 x 165
Stravimech Bearing-S1-1180-DP	002092	10	10.75	300 x 250 x 325
Stravimech Bearing-S1-1575-DP	002095	10	11.11	300 x 250 x 325
Stravimech Bearing-S1-1970-DP	002098	10	11.72	300 x 250 x 325
Stravimech Bearing-S1-2755-DP	002101	10	12.07	300 x 250 x 325
Stravimech Bearing-S1-3545-DP	002104	10	12.37	300 x 250 x 325
Stravimech Bearing-S1-4330-DP	002107	10	13.42	300 x 250 x 325



PHYSICAL & MECHANICAL PROPERTIES

Model	Height*	Design Load	Natural Frequency at Design Load	Load Range	Resistance to Uplift	Lateral Stiffness	Maximum Allowed Lateral Load	Spring Colour
	mm	N	Hz	N	N	N/mm	N	
Stravimech Bearing-S1-90	71	90	4	80-150	30	5,65	103	Orange 
Stravimech Bearing-S1-155		155		140-250	50	12,86	172	Purple 
Stravimech Bearing-S1-310		310		160-500	100	20,88	343	Green 
Stravimech Bearing-S1-465		465		390-750	155	30,95	515	Blue 
Stravimech Bearing-S1-620		620		460-1000	200	37,07	687	Red 
Stravimech Bearing-S1-775		775		660-1250	260	50,92	858	Pink 
Stravimech Bearing-S1-1180	111	1180	3	710-1500	390	29,01	1030	Green 
Stravimech Bearing-S1-1575		1575		860-2000	475	38,4	1373	Yellow 
Stravimech Bearing-S1-1970		1970		1120-2500	630	46,22	1717	Brown 
Stravimech Bearing-S1-2755		2755		1500-3500	750	63,57	2403	Grey 
Stravimech Bearing-S1-3545		3545		1930-4500	800	81,31	3090	Orange 
Stravimech Bearing-S1-4330		4330		2360-5000	840	89,4	3777	Black 

*Height of Stravimech Bearing-S1 with no mounting plate.

Options with bottom mounting plate have 3 mm extra, and the options with bottom and top mounting plates have 6 mm extra.

Notes:

- The products are suited to a C3 (medium duration) environment (urban and industrial atmospheres, moderate sulphur dioxide pollution, coastal areas with low salt content).
- Resistance to uplift is tested at room temperature.

S1-90 to S1-775 SERIES

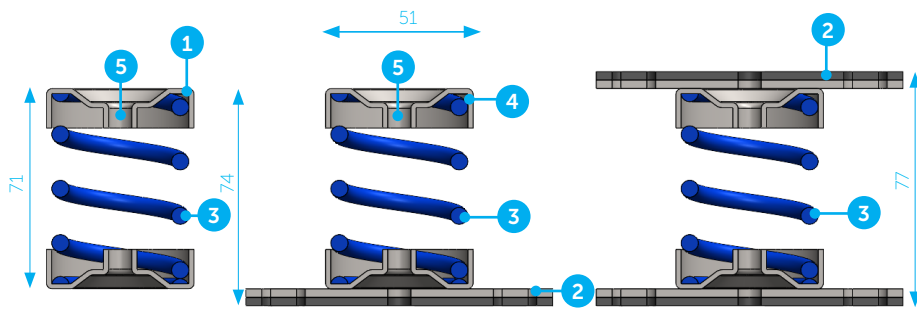

1. Steel bushings
2. Mounting plate
3. Polyester-based coated springs
4. Visco-elastic putty as soundstop
5. M8 threaded insert

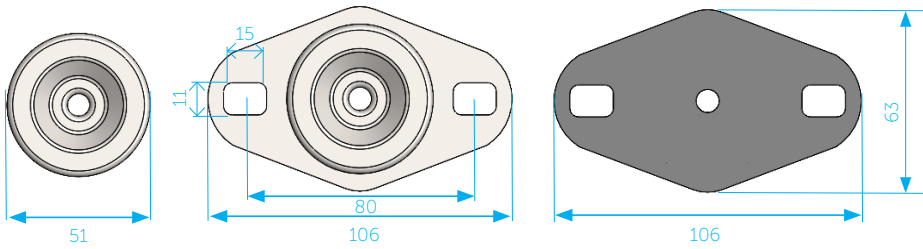

S1-1180 to S1-4330 SERIES

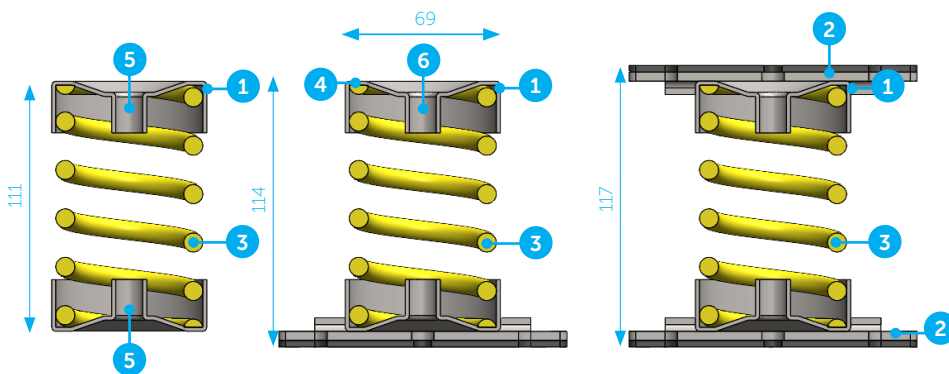

1. Steel bushings
2. Mounting plate
3. Polyester-based coated springs
4. Visco-elastic putty as soundstop
5. M8 threaded insert
6. M12 threaded insert

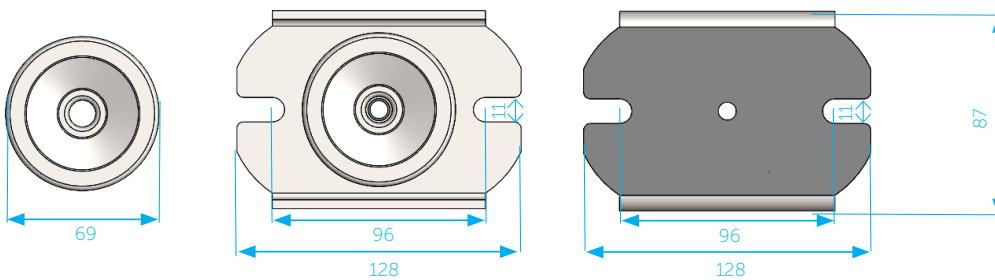

Note:
All dimensions in millimetres (mm).



To assess if the Stravimech system is appropriate CDM Stravitec's engineers will need the following information:

- Weight and load distribution of the machine to be supported on Stravimech Bearing supports
- Size and layout of support surfaces
- The dynamic loads generated by the machine
- Dimensional limits
- The required vibration isolation performance or natural frequency of the solution



Deflection vs Load

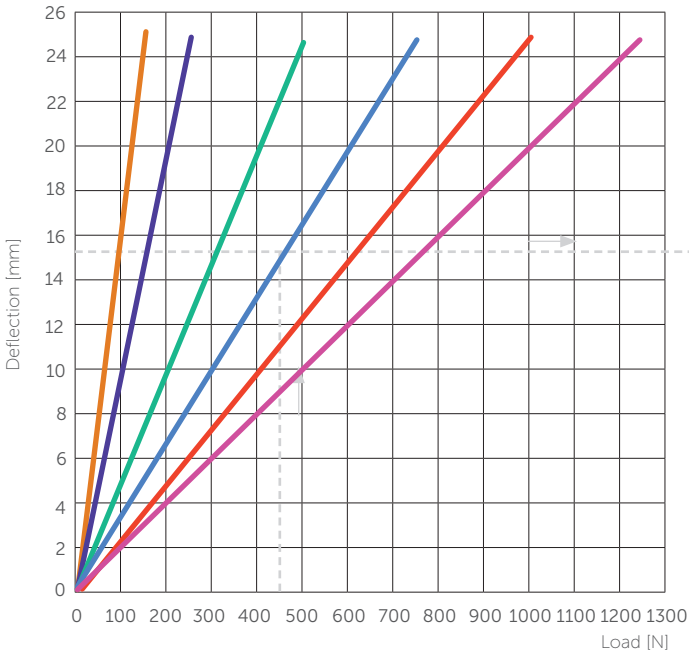

- Stravimech Bearing-S1-90
- Stravimech Bearing-S1-155
- Stravimech Bearing-S1-310
- Stravimech Bearing-S1-465
- Stravimech Bearing-S1-620
- Stravimech Bearing-S1-775

Deflection vs Natural Frequency

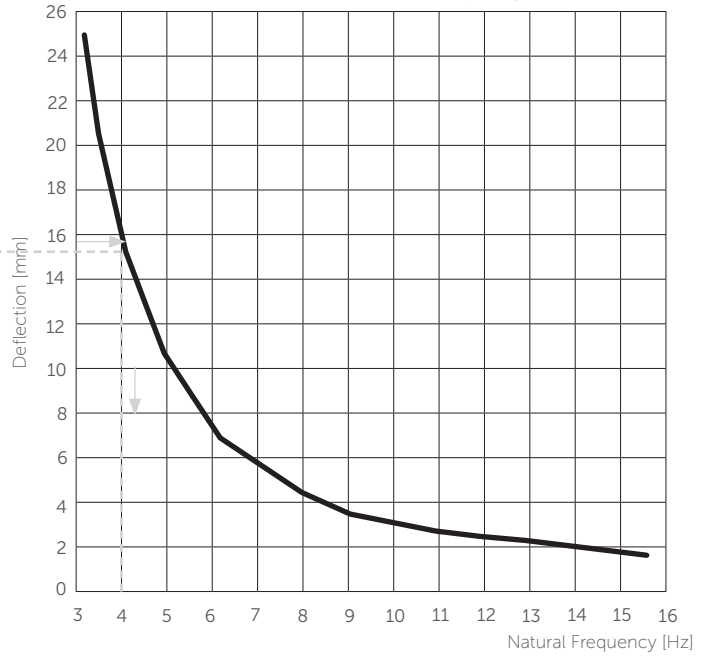

Deflection vs Load

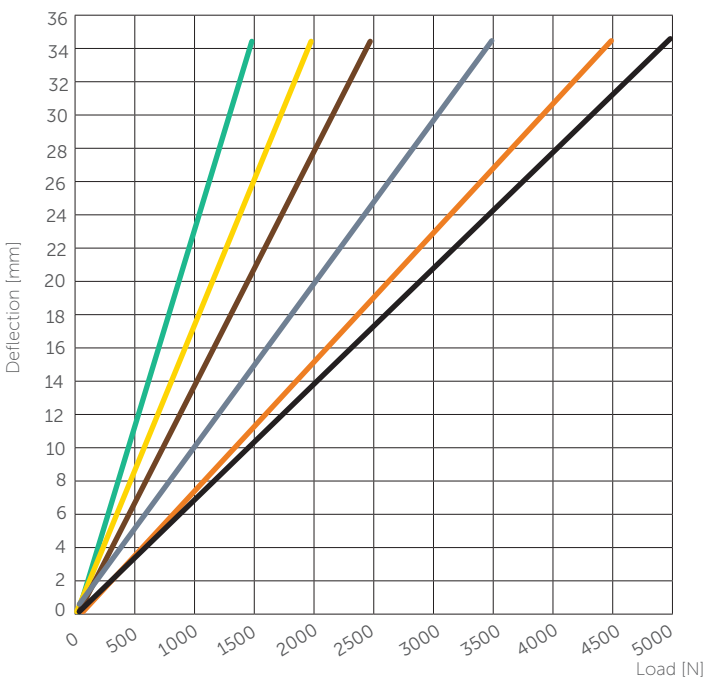

- Stravimech Bearing-S1-1180
- Stravimech Bearing-S1-1575
- Stravimech Bearing-S1-1970
- Stravimech Bearing-S1-2755
- Stravimech Bearing-S1-3545
- Stravimech Bearing-S1-4330

Deflection vs Natural Frequency

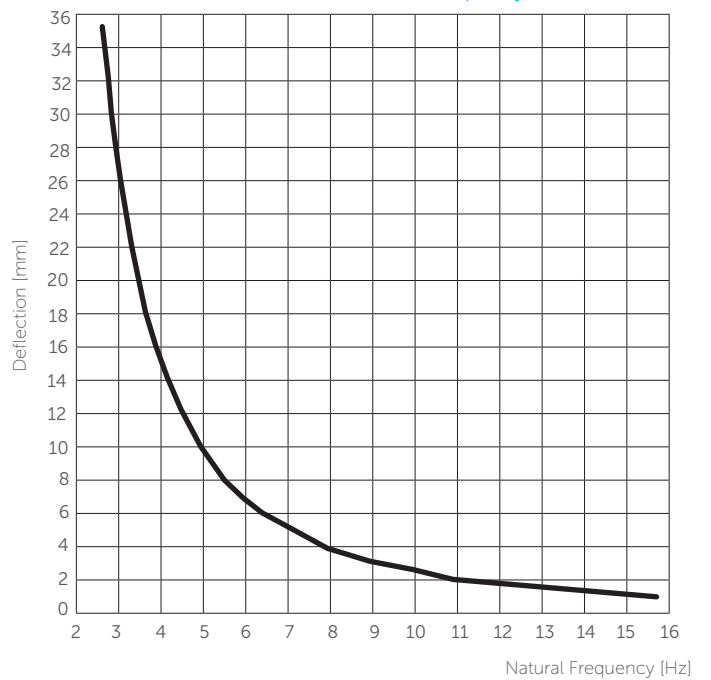

The natural frequency of a Stravimech isolator can be determined by its load. To start the calculation use the graph "deflection as function of load" this will provide the deflection at the specified load. Then moving horizontally to the right hand side plot "deflection as function of frequency" on which the corresponding natural frequency can be found. As an example, the natural frequency of a Stravimech Bearing-S1-465 loaded with 465 N is determined. The corresponding deflection is 15 mm. The natural frequency of a spring at 15 mm deflection is 4 Hz.



Level Set

Levelling kit consisting of a threaded rod with nuts and washers for height adjustment.

Available in M8 and M12.

Compatibility:

S1-90 to S1-775 Series: M8

S1-90-SP to S1-775-SP Series: M8

S1-1180 to S1-4330 Series: M8

S1-1180-SP to S1-4330-SP Series: M12

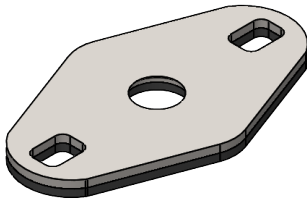

**Base Set
(S1-90 to S1-775 Series)**

Base plate featuring an elastomeric layer that improves anti-slip properties and adapts to surface irregularities, and holes allowing for easy anchoring.

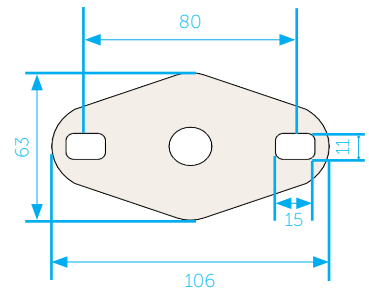

Note: All dimensions in milimeters (mm).

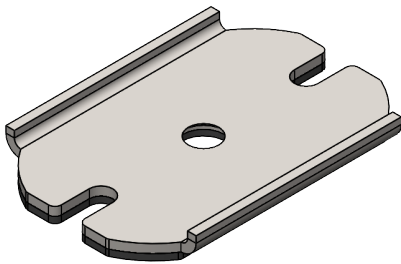

**Base Set
(S1-1180 to S1-4330 Series)**

Base plate featuring an elastomeric layer that improves anti-slip properties and adapts to surface irregularities, and holes allowing for easy anchoring.

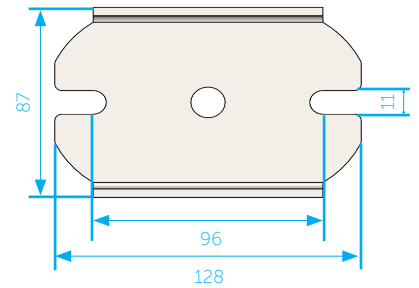

Note: All dimensions in milimeters (mm).

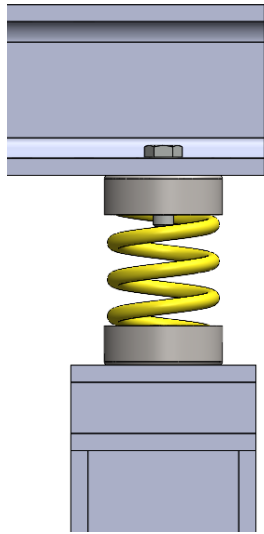

No mounting plate

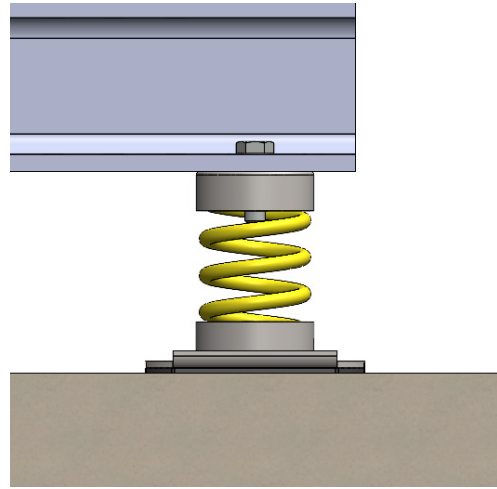

Bottom mounting plate (SP)

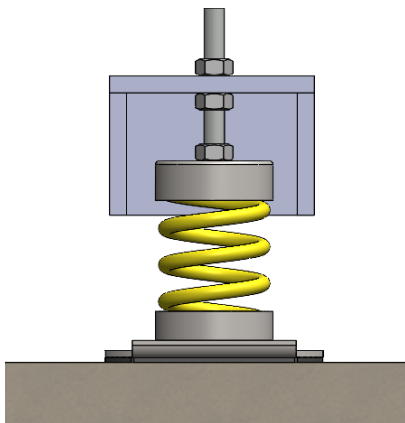

Bottom mounting plate (SP) with levelling*

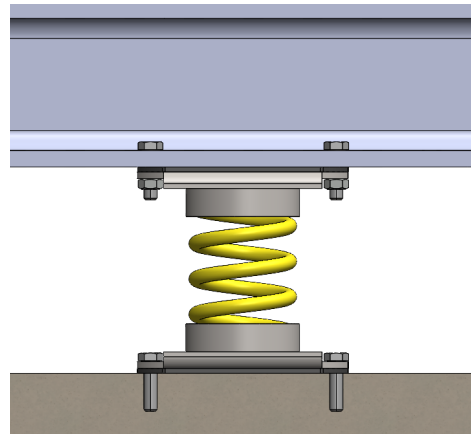

Bottom and top mounting plate (DP)

*Levelling set available as accessory.

DISCLAIMER

This information is accurate to the best of our knowledge at the time of issue. Information, data and recommendations provided are based on industry accepted testing and prior product usage. It is intended as descriptive of the general capabilities and performance of our products and does not endorse applicability for any particular project. We reserve the right to change products, performance, and data without notice. This document replaces all information supplied prior to the publication hereof.



Vismeerstraat 3 - 5384 VL Heesch
0800 55555 44
info@delta-l.nl
<https://www.delta-l.nl>

IBAN: NL79 RABO 0375036717
BIC: RABONL2U
BTW: NL811318539B01
KvK: 08071864

Delta-L B.V. | CDM Stravitec Nederland

Delta-L is specialist op het gebied van geluidsisolatie en trillingsisolatie en ontwerpt, levert en monteert diverse systemen voor akoestische ontkoppelingen in de bouw en industrie.

Delta-L vertegenwoordigt CDM Stravitec op de Nederlandse markt. CDM Stravitec is opgericht in 1951 en is marktleider op het gebied van akoestische oplegsystemen voor de bouw en industrie en is actief in tientallen landen (30+ vestigingen wereldwijd).

Door onze expertise, jarenlange ervaring en grote database aan meetresultaten van zowel interne en externe laboratorium metingen als in situ metingen hebben we door de jaren heen een uitgebreid assortiment aan akoestische materialen ontwikkeld, welke we op een slimme manier verwerken in diverse akoestische systemen.

Tevens zijn wij hierdoor in staat u adequaat van dienst te zijn bij elke stap in het proces: analyse van het geluid of trilling probleem, het aanleveren van een akoestisch ontwerp, optimalisatie van het ontwerp, productie, levering en montage.

Er wordt continu gewerkt aan innovatie en optimalisatie van de akoestische systemen om uw wensen en eisen om te zetten in een deskundig advies op maat.